



汎用タイプ

NY9400DM NY9420DM

多彩な点滅パターン、複数台の点滅同期、減光入力対応、ヨーロッパ規格 ECE 適合



NY9400DM

NY9420DM



汎用タイプ

NY9400DS NY9420DS

多彩な点滅パターン、複数台の点滅同期、国際規格 SAE 適合



NY9400DS

NY9420DS

寸法図・配線図 (単位: mm)

[NY9400DM□]

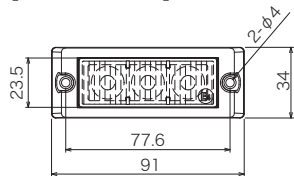

[NY9420DM□]

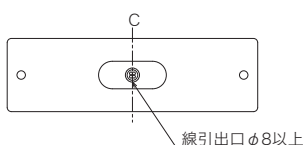
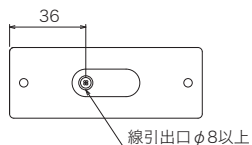
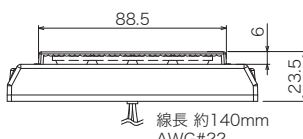
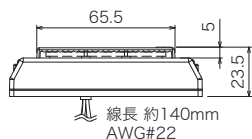
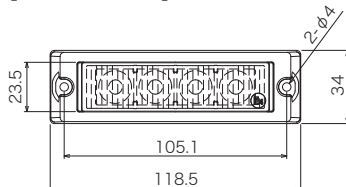

LENS	PC
BODY	AL
LED	R : 3W×3 Y : 1W×3 G : 1W×3 B : 5W×3

LENS	PC
BODY	AL
LED	R : 3W×4 Y : 1W×4 B : 5W×4

寸法図・配線図 (単位: mm)

[NY9400DS□]

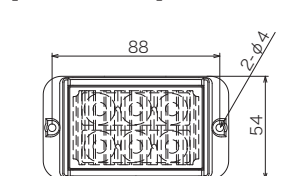

[NY9420DS□]

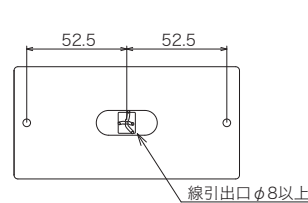
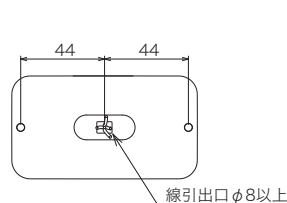
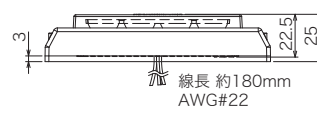
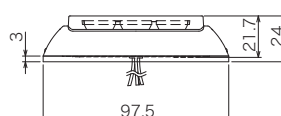
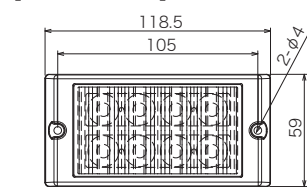

LENS	PC
BODY	AL
LED	1W×6

LENS	PC
BODY	AL
LED	1W×8

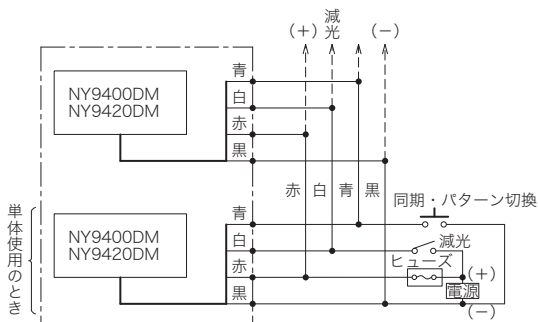

青色は同期とパターン切替共通になります。

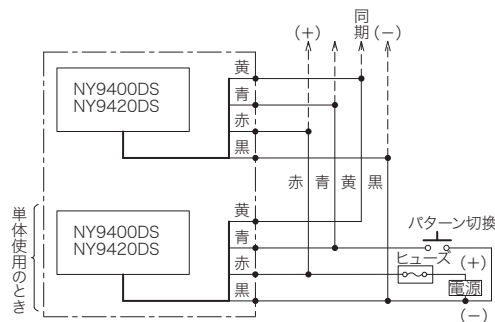

機種表

分類	型式	定格電圧	表示機能			消費電力	質量	定価 (税別)
			減光入力	点滅	同期			
汎用タイプ	NY9400DM□	DC12 ~ 24V	●	●16パターン	●	4.2 ~ 5.7W	0.06kg	8,500円
	NY9420DM□			●20パターン		6.1 ~ 12.1W	0.08kg	10,300円
汎用タイプ	NY9400DS□	DC12 ~ 24V	-	●12パターン	●	6.6 ~ 8.3W	0.11kg	15,200円
	NY9420DS□			●76パターン		11.8W	0.17kg	18,600円

■型式の□には色記号を入れます。NY9400DMは赤：R、黄：Y、緑：G、青：B。NY9420DM・NY9400DS・NY9420DSは赤：R、黄：Y、青：B。